

# Primordial Origin of Magnetic Fields in the Galaxy & Galaxies

- **Tight Link between GC  
and Cosmic B –**

Y. Sofue<sup>1</sup>, M. Machida<sup>2</sup>, T. Kudoh<sup>3</sup>

(1. Kagoshima U. & U .Tokyo, 2.Nagoya Univ. 3. NAOJ)

# 1. Vertical B in GC vs Spiral/Ring/Loop Fields in the Disks

M51, M81, M33,  
Spiral/Ring + GC V field

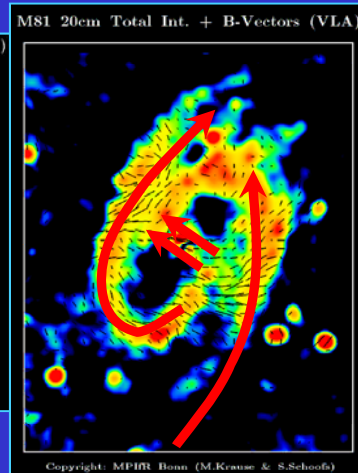
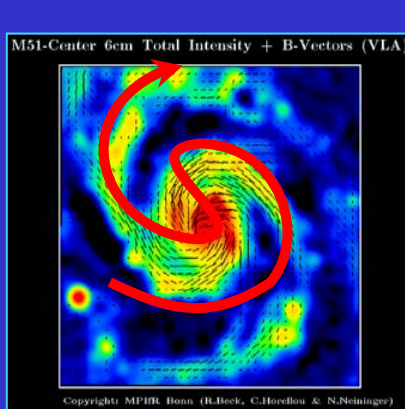

NGC 253  
Helical B, Loops, Jets, Spicules



NGC 2903,  
Helical jets

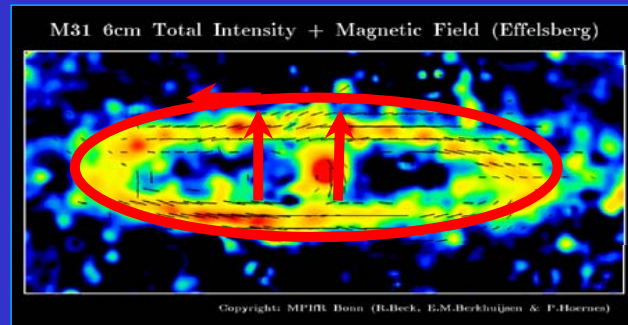
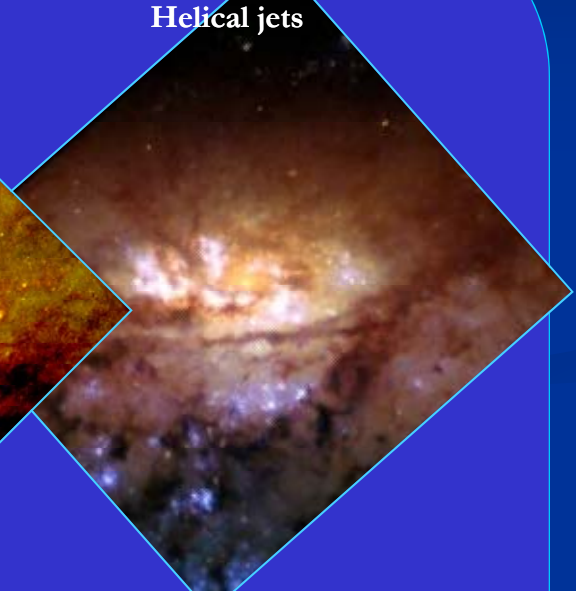

# Galactic Shells, Loops, Jets, Helix

## 1970's ~ HI, Dust, cold gas

HI shells, worms  
(Heiles 2004)

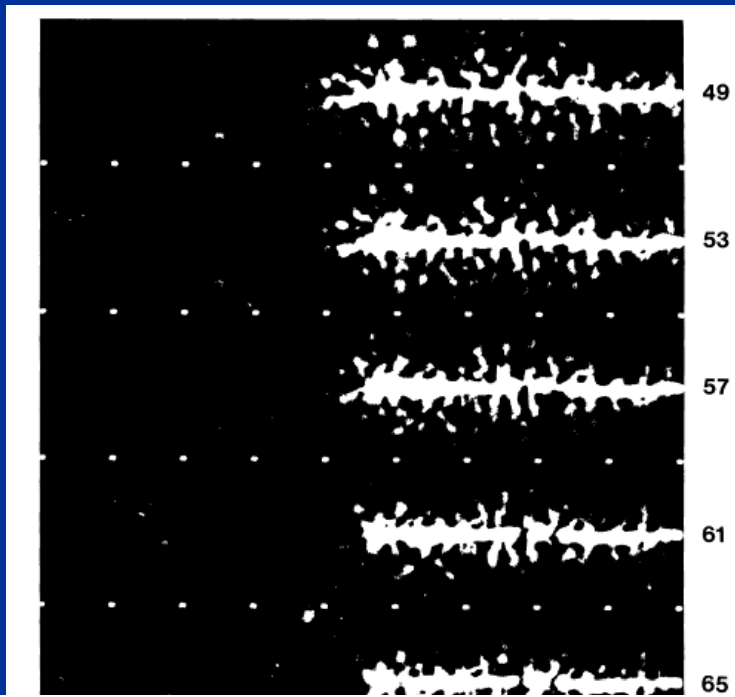

HI SHELLS, SUPERSHELLS, SHELL-LIKE OBJECTS, AND "WORMS"

CARL HEILES

G40 1-kpc HI jets  
(Sofue 2004)

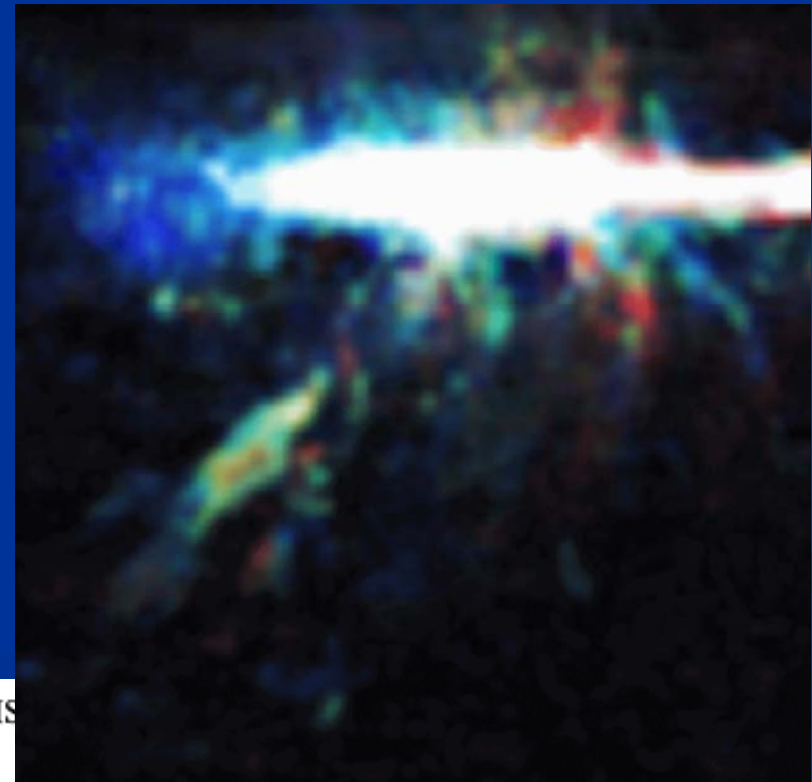

# Threads

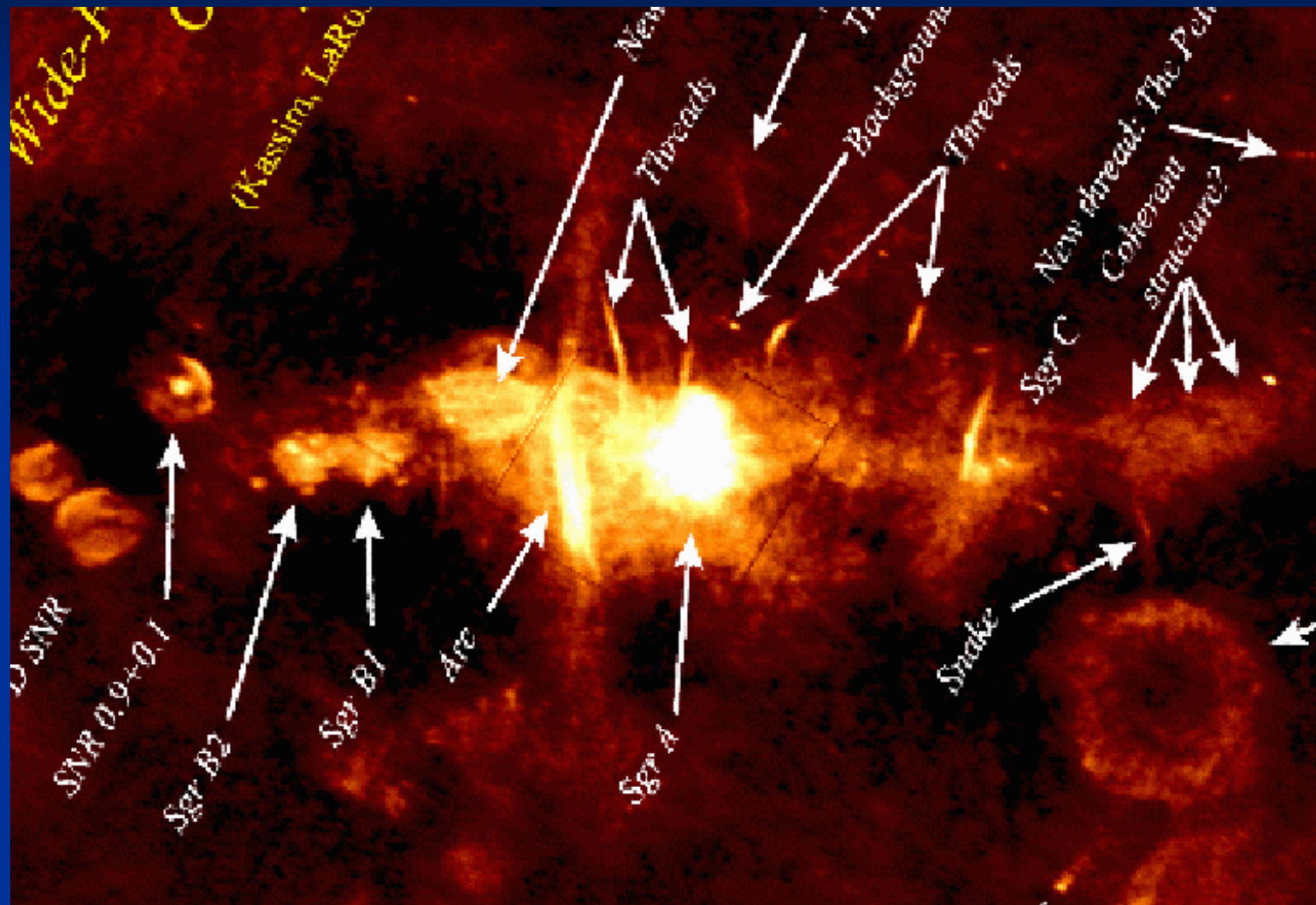

# Galactic Center Vertical B

NRO 45m, Bonn 100m Tsuboi et al, 1986, Sofue, et al. 1987

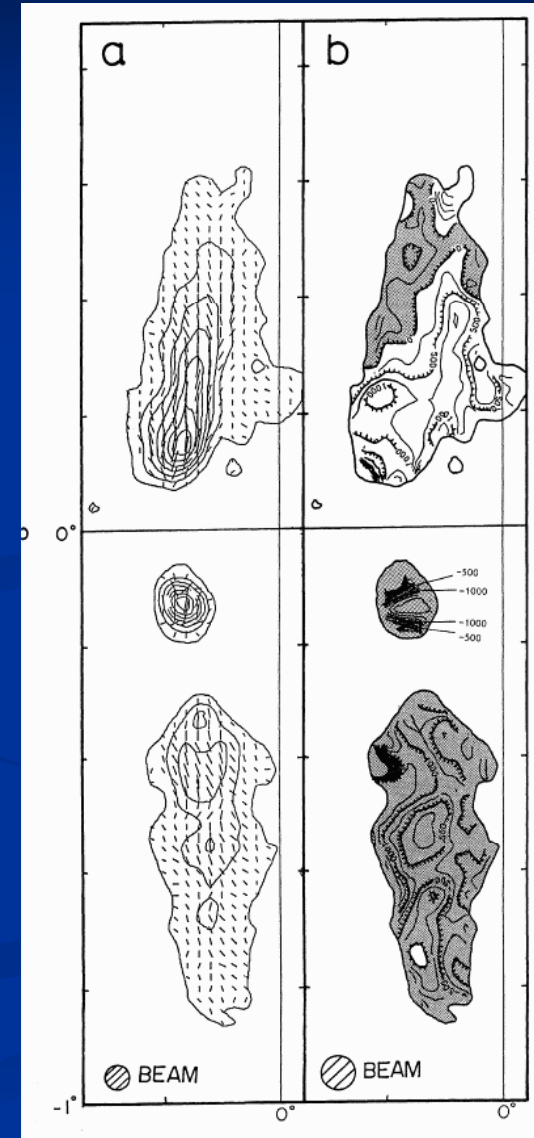
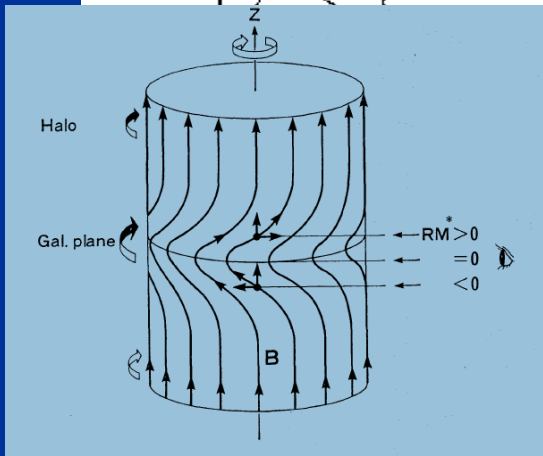
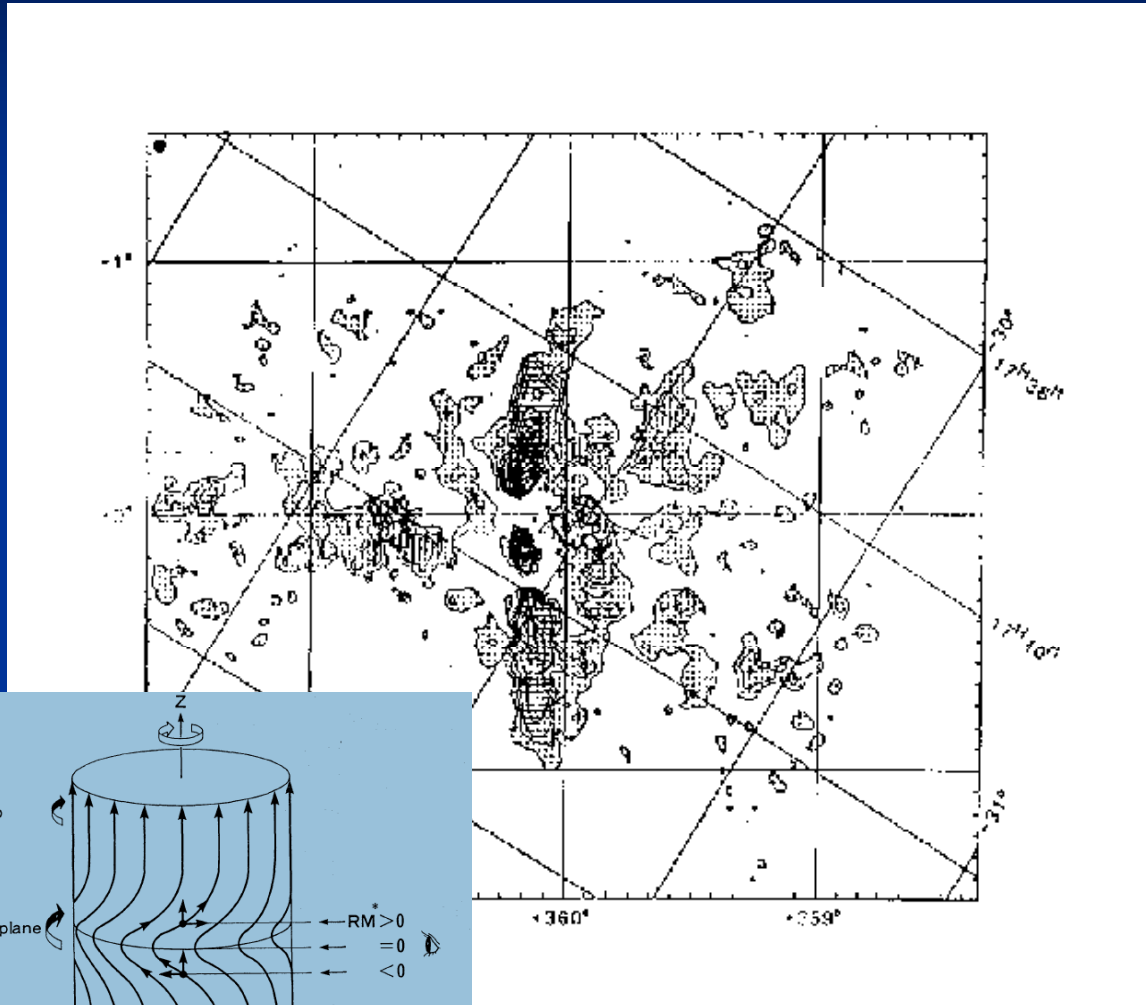

# Galactic Center Vertical B: Helical B, Jets, Loops

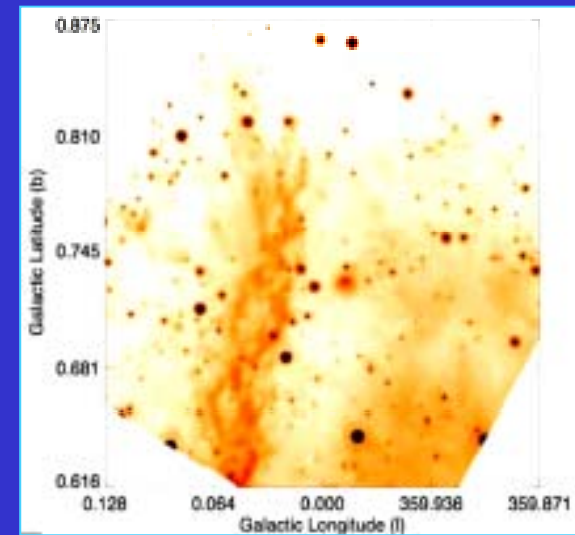
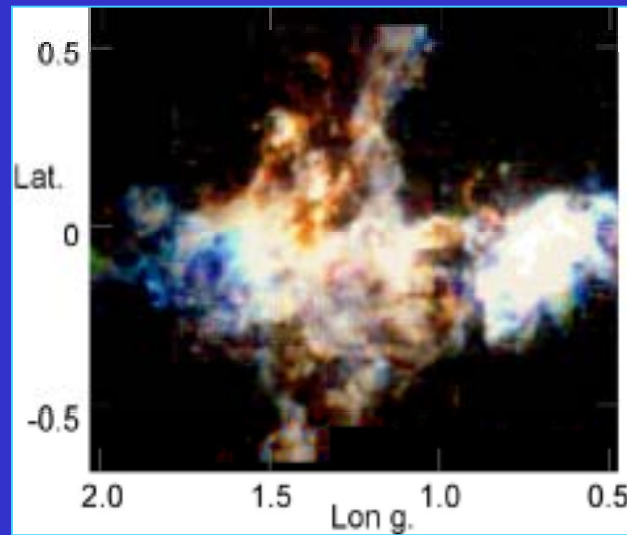
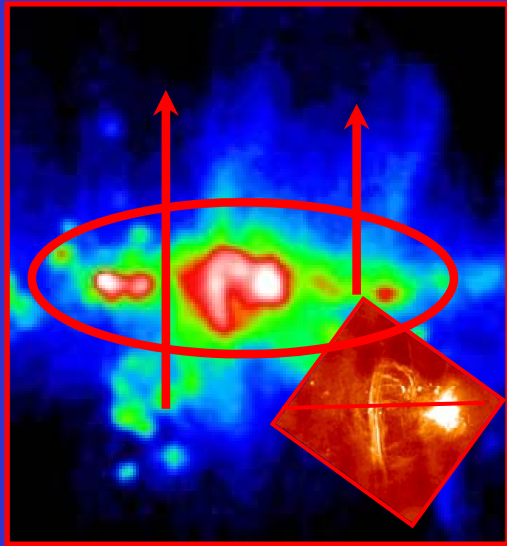

# NGC253

## Jets, Loops

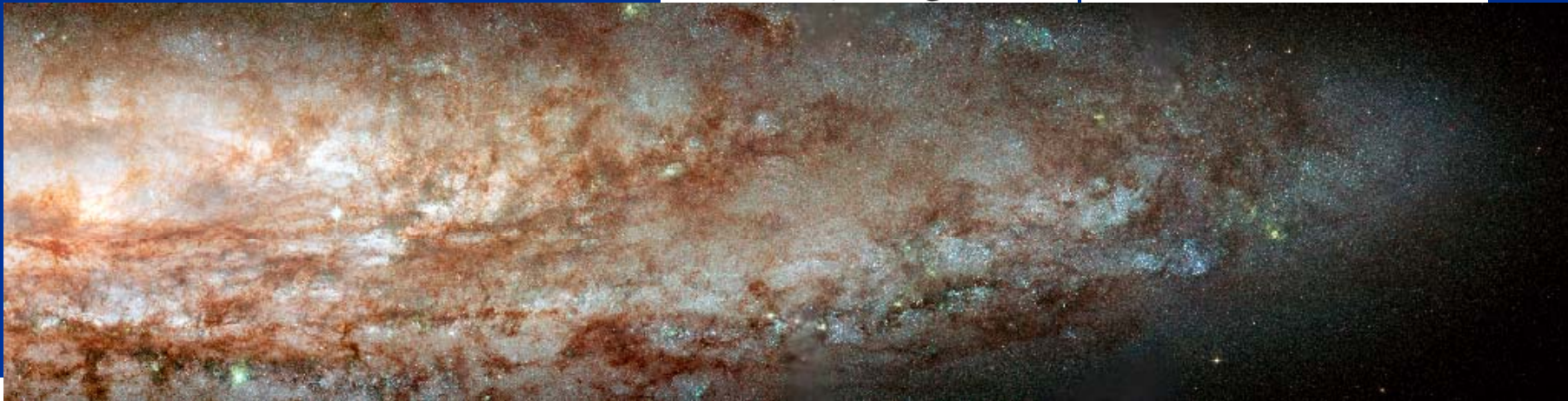

NGC 253, NGC 2903

Central Helical Jets

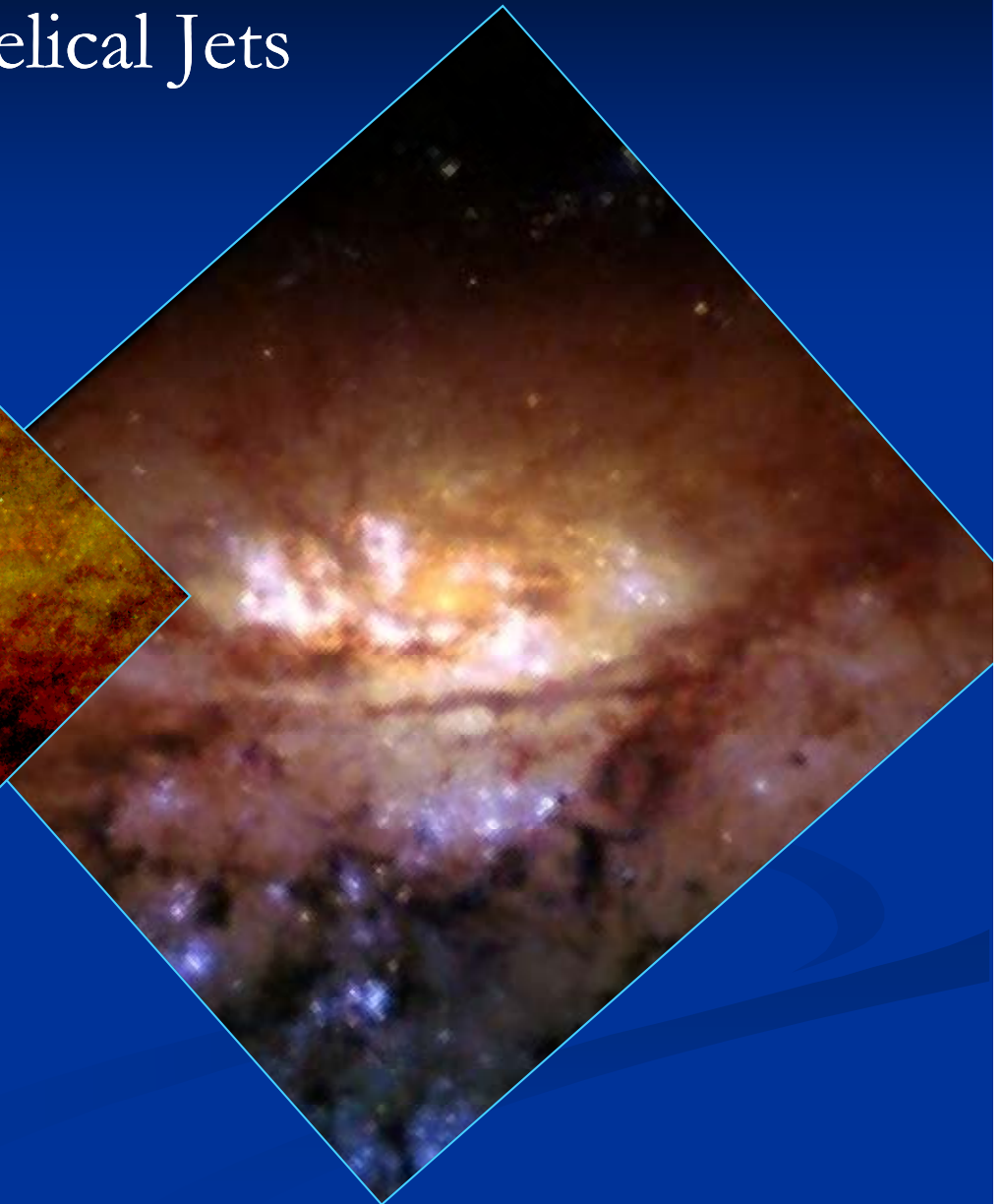
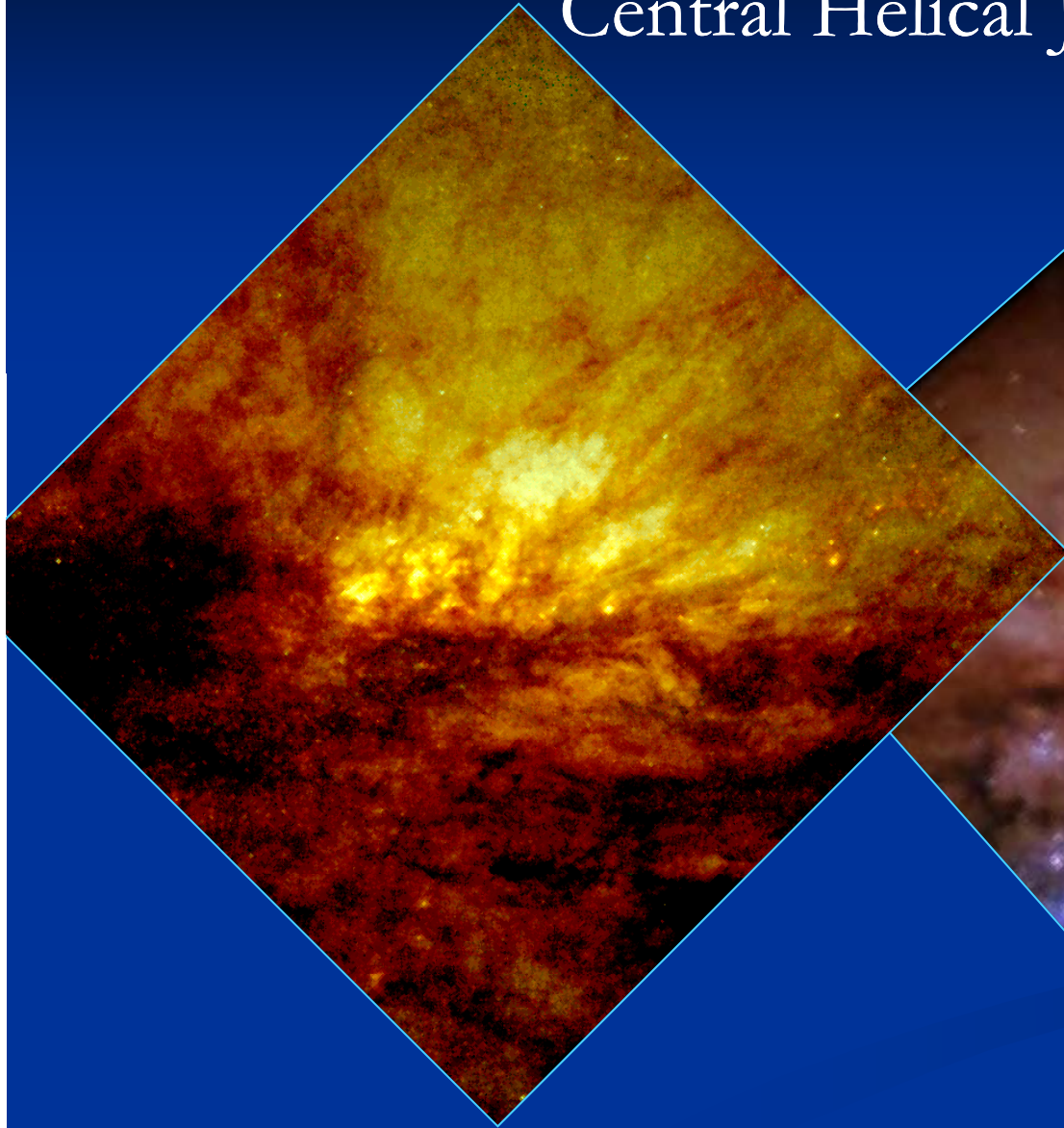



# Loop: N2903



# M51, M81, M31, Spiral/Ring ⊥ GC V field

M51-Center 6cm Total Intensity + B-Vectors (VLA)

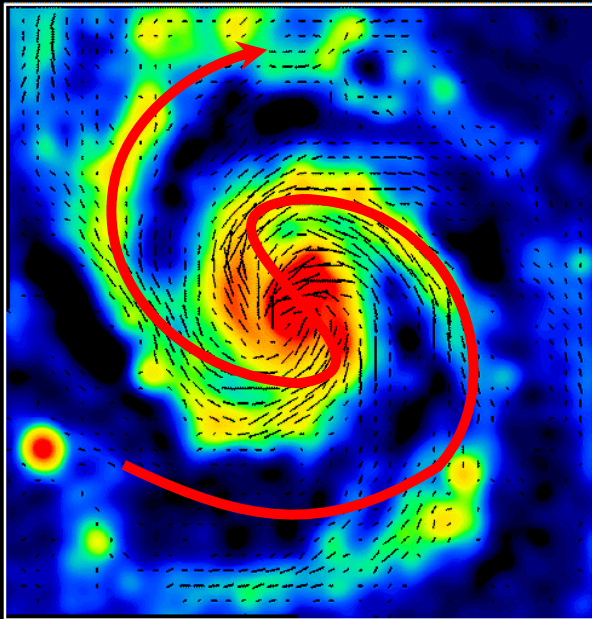

Copyright: MPIfR Bonn (R.Beck, C.Horellou & N.Neinger)

M81 20cm Total Int. + B-Vectors (VLA)

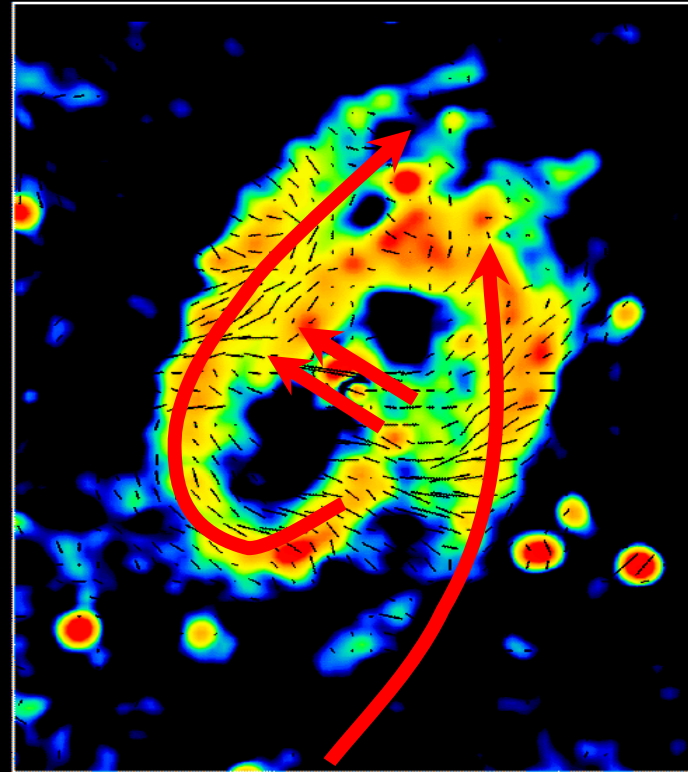

Copyright: MPIfR Bonn (M.Krause & S.Schoofs)

M31 6cm Total Intensity + Magnetic Field (Effelsberg)

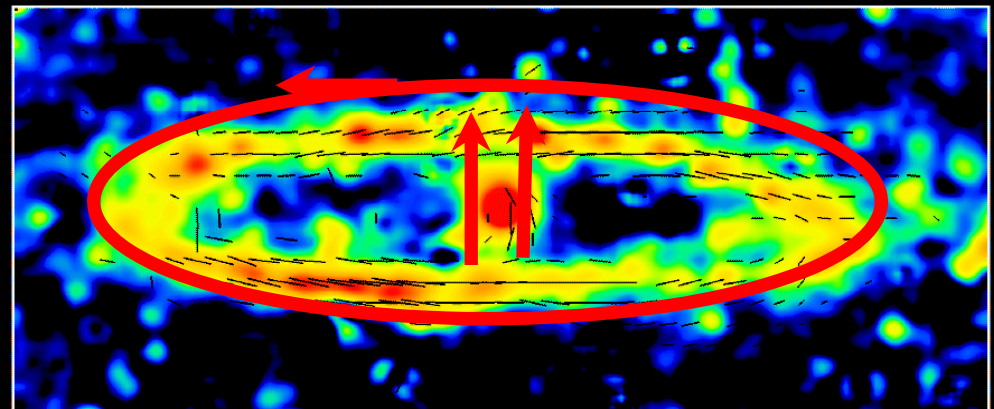

Copyright: MPIfR Bonn (R.Beck, E.M.Berkhuijsen & P.Hoernes)

## 2. Primordial origin for S, A, R, & V fields

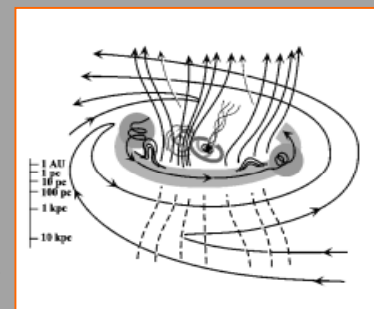
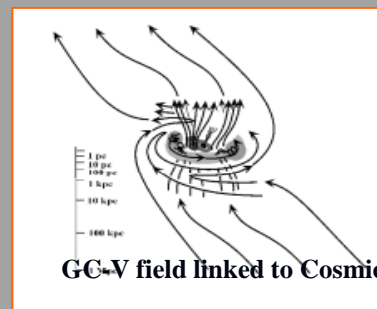
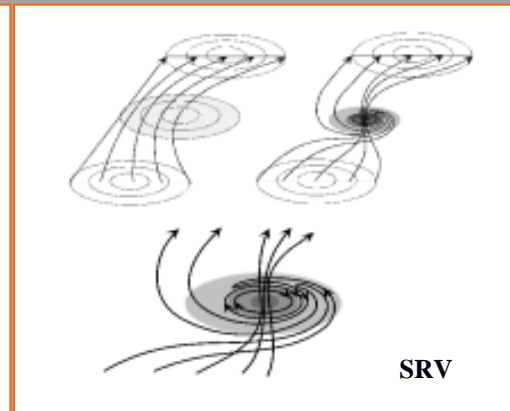
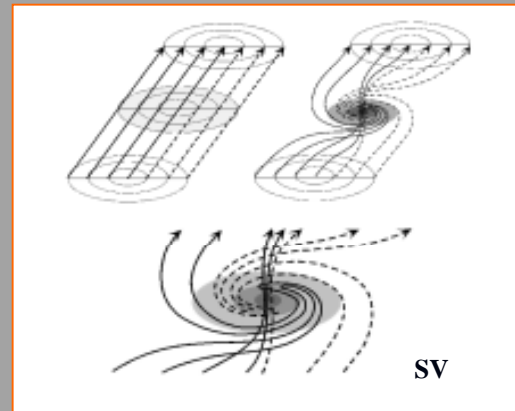
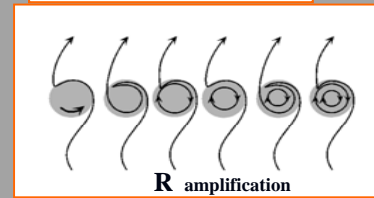
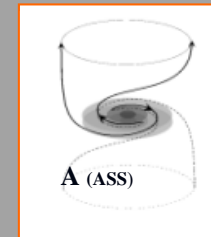
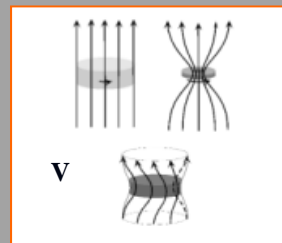
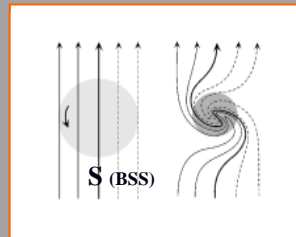

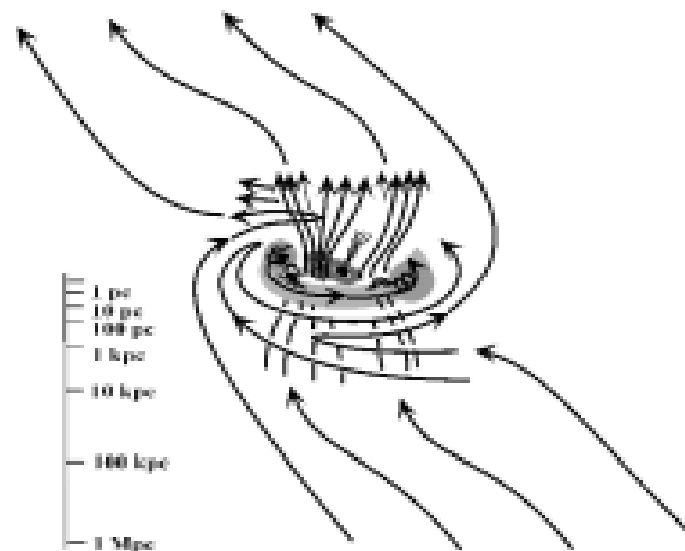
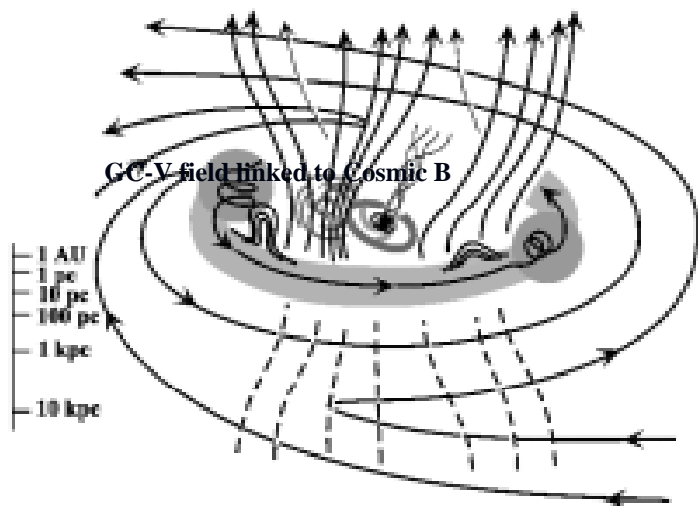
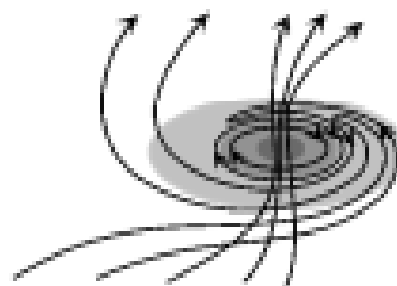
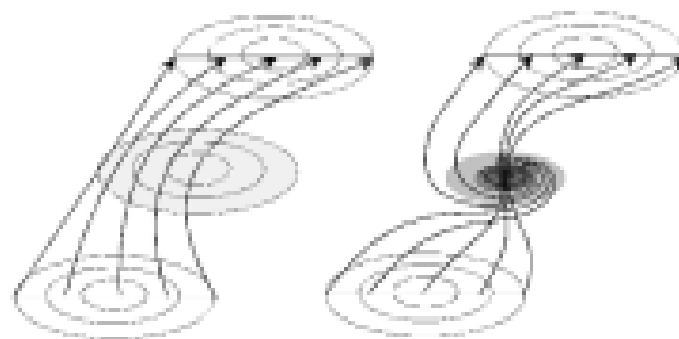
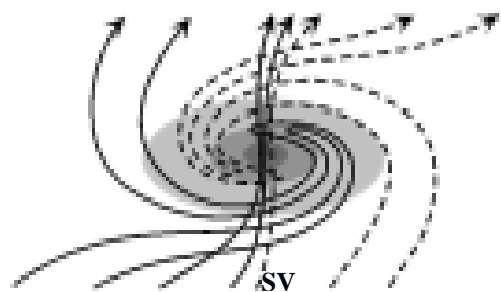
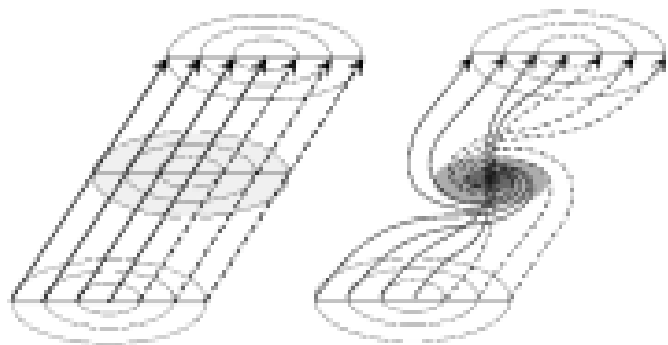

# 3. MHD Simulation $i=0, 45, 89, 90$ deg, 10 kpc disk

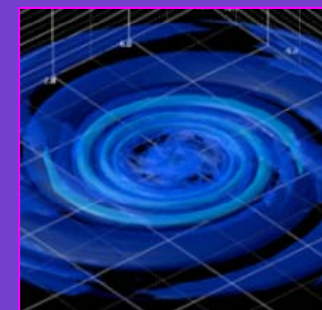
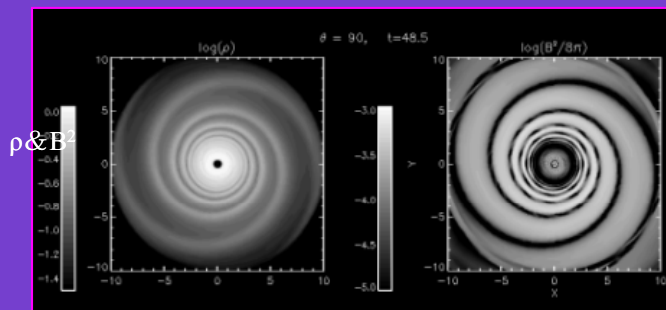
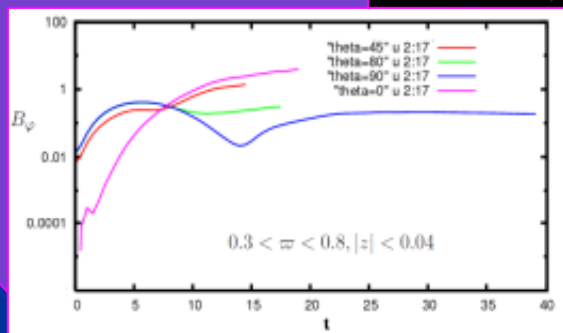
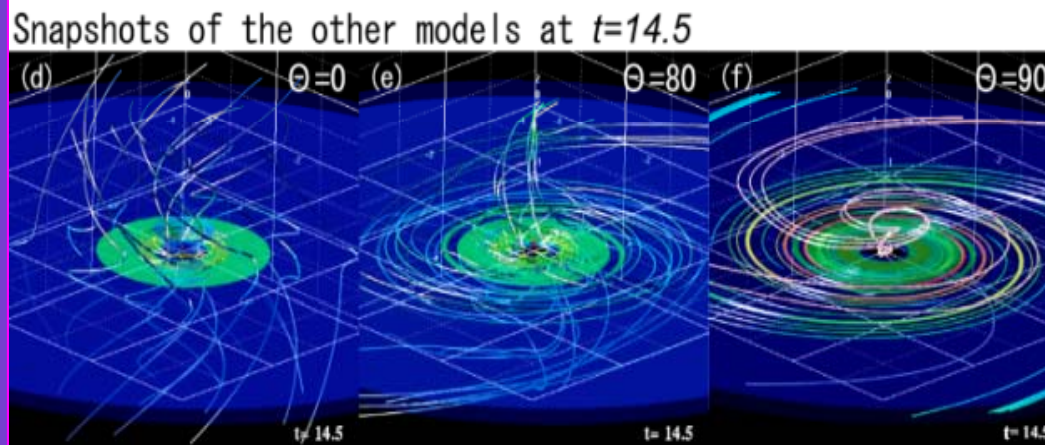
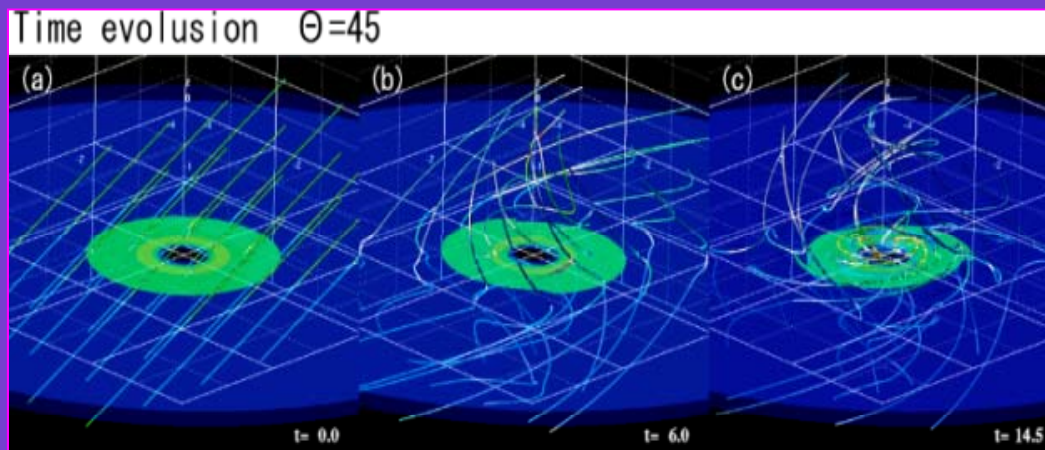

TIME EVOLUTION  $\Theta = 45$

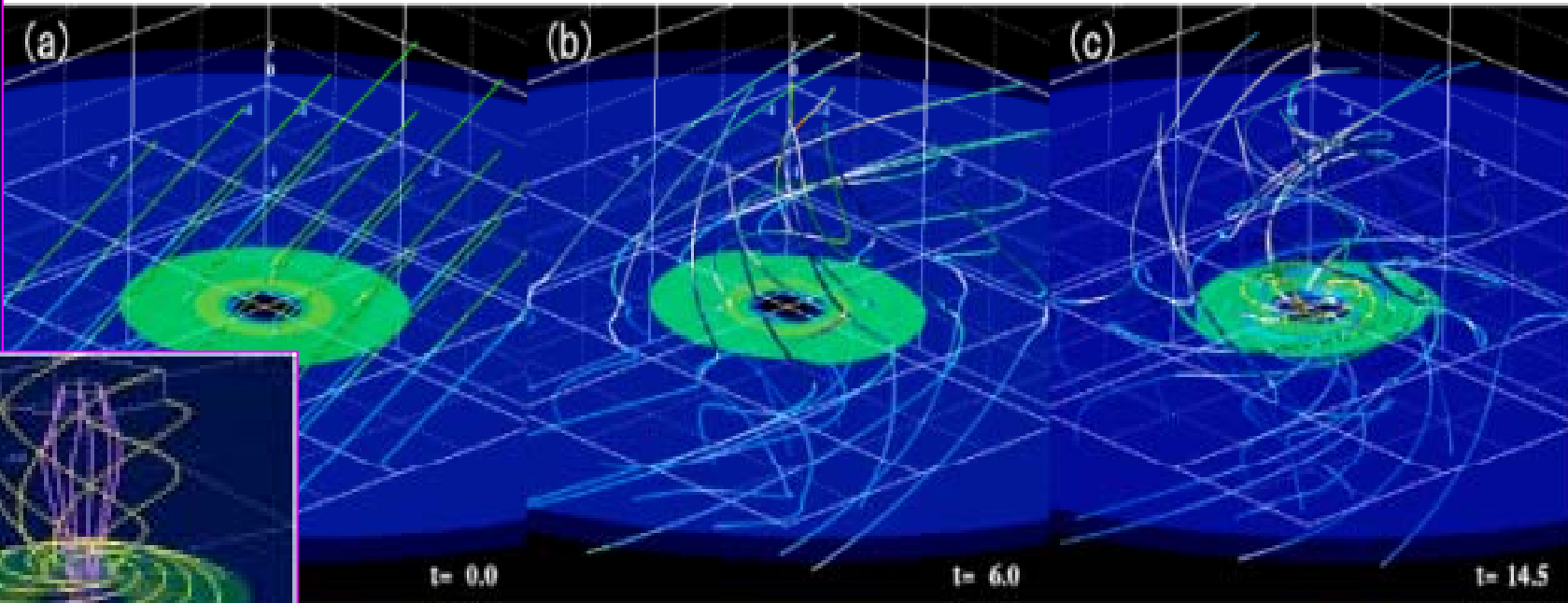

f the other models at  $t=14.5$

